

General specifications		
Spa Package dimension	2420x1200x2200mm	
Cabinet Package dimension	2400x900x1470mm	
Spa Package weight		333 Kg
Cabinet Package Weight		400 Kg
	HPL	Solid Surface

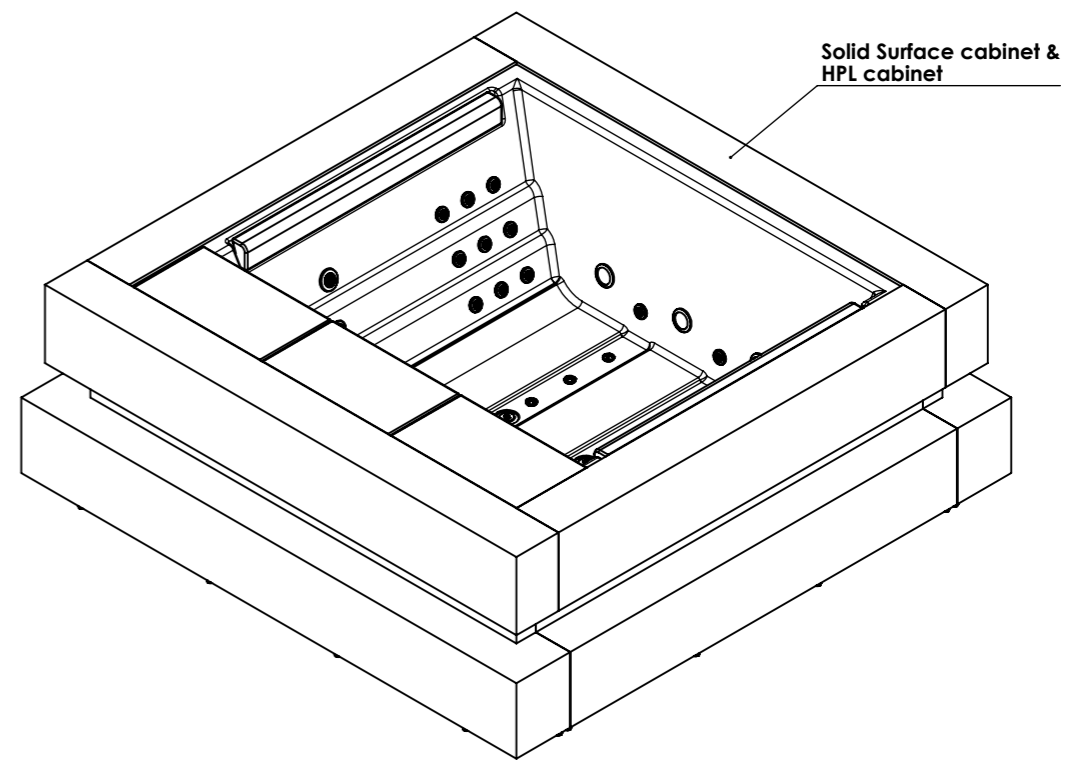
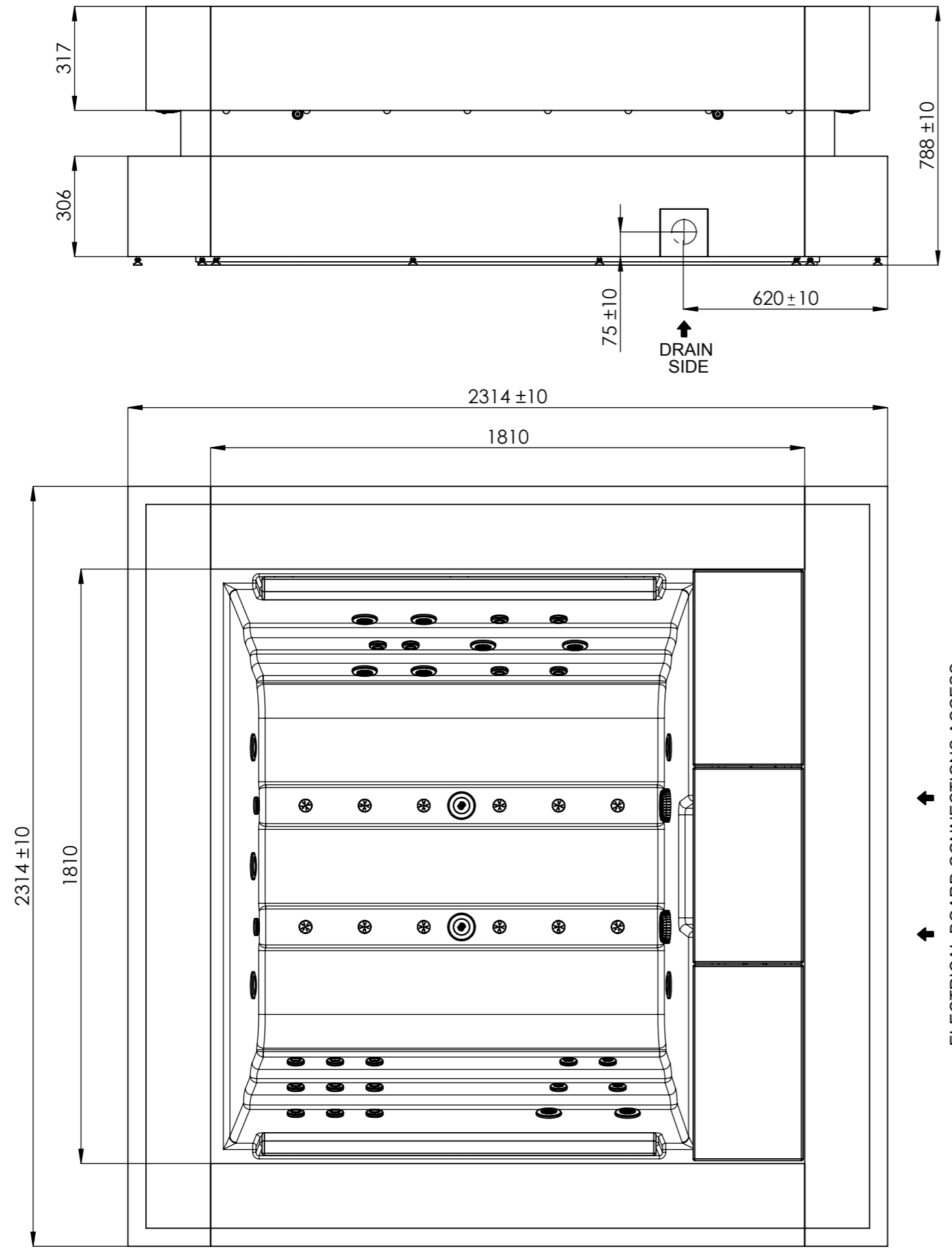

VALID FROM SERIAL NUMBER: **53186**
VALIDO A PARTIR DEL NÚMERO DE SERIE: 53186

↑
↑
ELECTRICAL BOARD CONNECTIONS ACCESS

According to our policy of continuous improvement, dimensions, features or components of this product can be partially or completely changed without prior notice. It's Customer responsibility to verify that this is the last version of the drawing

Change No.	Date	Name	Modification
10	18/09/2018	A.Miquel	Jets (CMP) changed.
09	08/05/2017	O. Faura	Changing of electronic parts references.
08	07/10/2014	I.Pozo	Change Blower 700W and add transformer/controler
07	13/01/2017	R.Vallès	Update measures

Remarks Dimensions in mm. General Tolerances +/- 10mm			COMMERCIAL			
Drawn	13/01/2017	R.Vallès		Part Number 56541	Rev. 10	First Angle Projection
Checked	13/01/2017	V. Saiz				
Scale 1:15	General Tolerance DIN 7168 ISO 2768g					
Sheet 1/3	Property of IBERSPA S.L. Avda. Pla d'Urgell 2-8 25200 Cervera, Spain. Don't use without permission. Keep this information confidential and use it solely for the permitted purpose.					

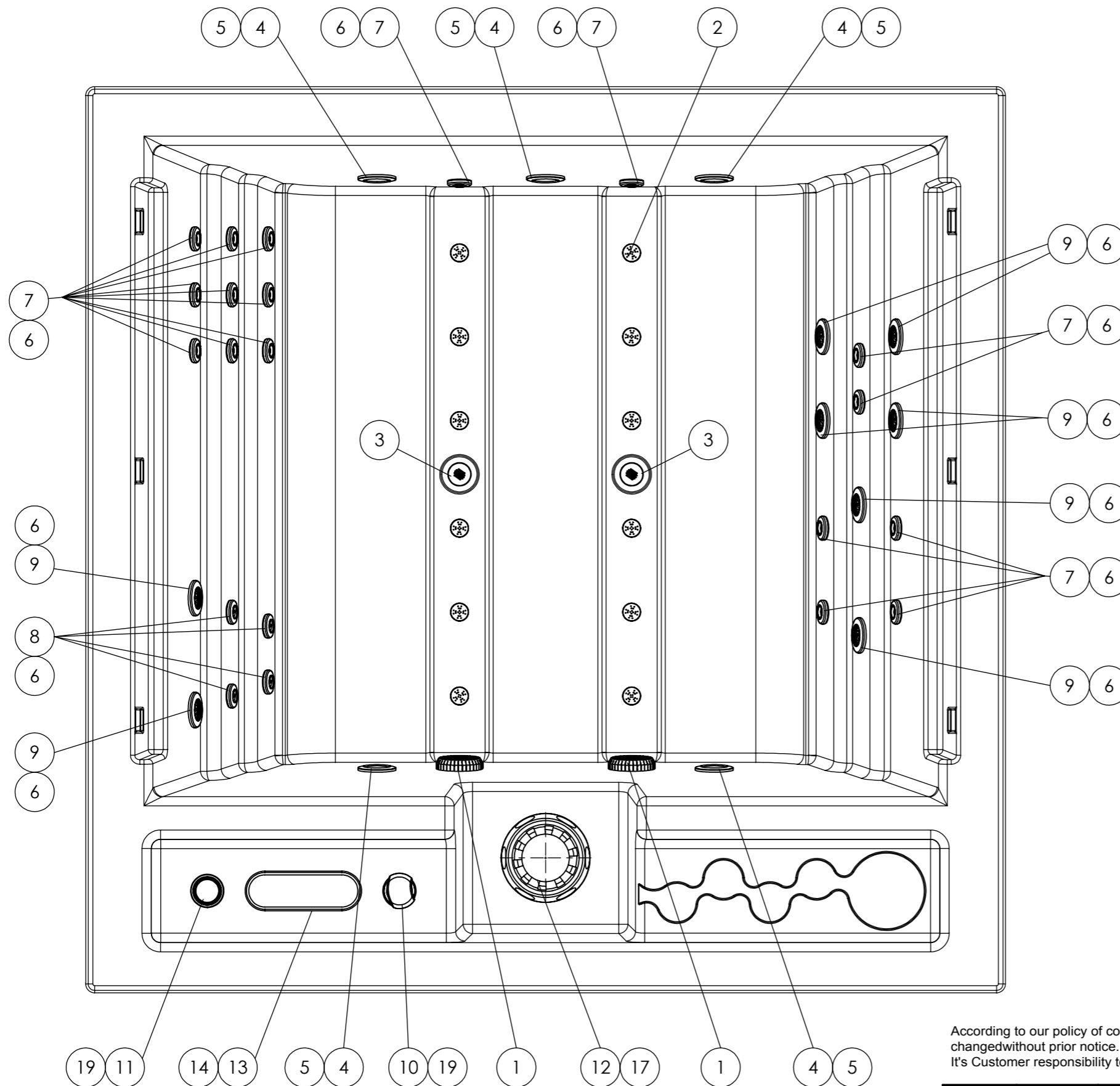

Position Num.	PartNo SPARE	Description SPARE	Qty.
1	RPOR0225	GREY SPA DRAIN 2" ADAPTOR SOCKET D.50	2
2	REMP0046	WHITE-STAINLESS STEEL AIR NOZZLE	12
3	RPOR0003	GREY DRAIN SET - BODY+COVER+ASSEMBLY	2
4	RPOR0239	SPOTLIGHT LED SET RD	5
5	RPOR0252	LED SLAVE LIGHT	5
6	RPOR0375	JET BODY SET CMP 2"	29
7	RPOR0375-A	FRONTAL JET 2" STAINLESS STEEL DIRECTIONAL	17
8	RPOR0375-C	FRONTAL JET 2" SS ROTO	4
9	RPOR0375-D	FRONTAL JET 2" LARGE FACE SS ROTO	8
10	RPOR0261	VENTURY CONTROLLER SS	1
11	RPOR0264	AROMA DISPENSER ASM LIT	1
12	RPOR0238	SKIMERFILTER RD LOW PROFILE	1
13	RPOR0356	CONTROL PANEL TP800	1
14	RPOR0356-B	COVER DIGITAL AQUAVIA PANEL TP800 (1 PUMP + BLOWER)	1
15	RPOR0269	TOP COVER CUBE SPA	3
16	RPOR0270	HEADREST CUBE SPA	2
17	RPOR0247	FILTER CARTRIDGE SKIMFILTER RD	1
18	RPOR0136	DRAIN FILL VALVE (BLACK)	1
19	RPOR0267	4 LEDS LIGHTS POINTS	1
20	RPOR0280	LEDS TRANSFORMER 5V DC	1
21	RPOR0281	LEDS CONTROLER	1
22	RPOR0259	CABLE 4 OUTPUTS + LEDS	8
99			2

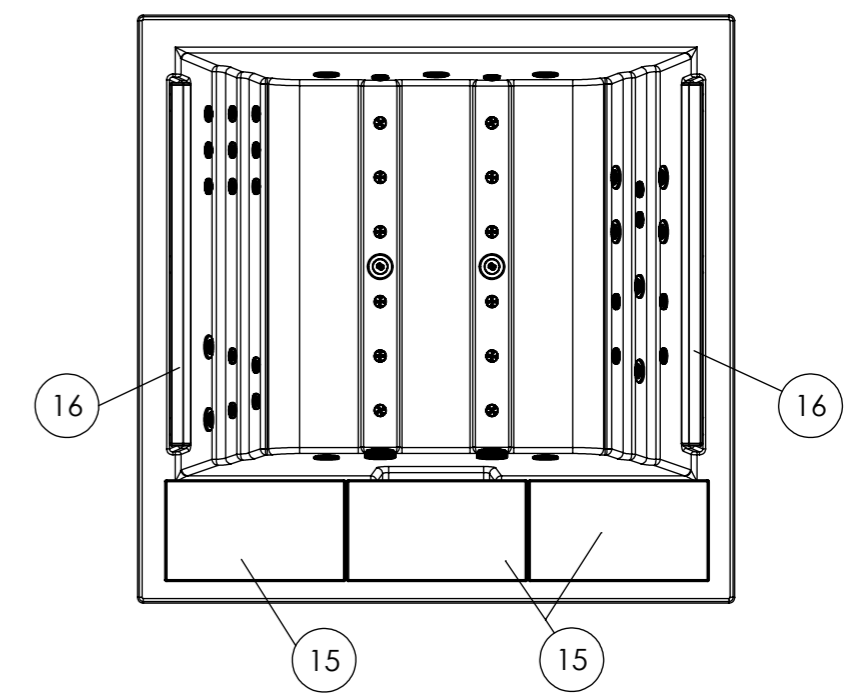

According to our policy of continuous improvement, dimensions, features or components of this product can be partially or completely changed without prior notice. It's Customer responsibility to verify that this is the last version of the drawing

10	18/09/2018	A. Miquel	Jets (CMP) changed.
09	08/05/2017	O. Faura	Changing of electronic parts references.
08	07/10/2014	I.Pozo	Change Blower 700W and add transformer/controler
07	13/01/2017	R.Vallès	Update measures
Change No.	Date	Name	Modification
Remarks			SPARE PARTS DRAWING
Dimensions in mm. General Tolerances +/- 10mm			
Drawn	13/01/2017	R.Vallès	
Checked	13/01/2017	V. Saiz	
Scale	1:10	General Tolerance	Part Number
Sheet	2/3	DIN 7168 ISO 2768g	56541
			Rev.
			10
			First Angle Projection

PUMPS SPARE CODES

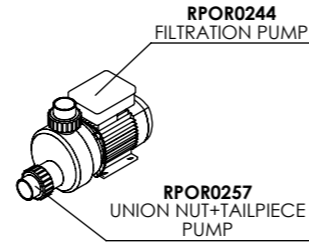
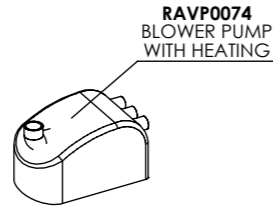
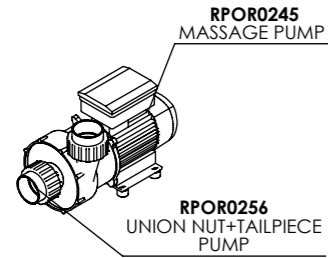

HEATER AND DESINFECTION SPARE CODES

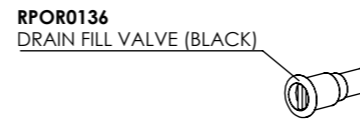
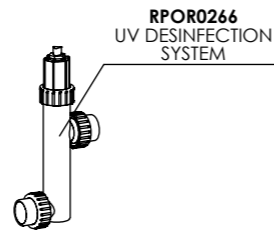
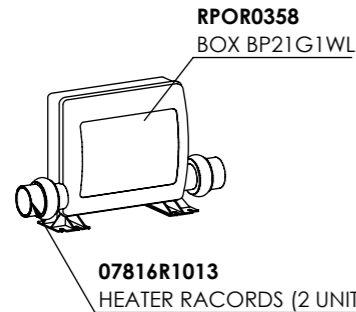

- RPOR0101 - TEMPERATURE PROBES GS I GL (x2)
- RPOR0105 - HEATER 3KW GS I GL
- RPOR0358-A - DIGITAL PANEL BP21G1WL
- RPOR0330 - EXPANDER BOARD KIT FOR SISTEM BP21G1WL
- RPOR0358-B - LEVEL SENSOR

AUDIO SPARE CODES

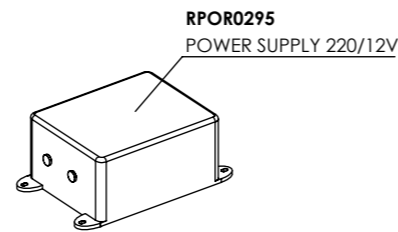
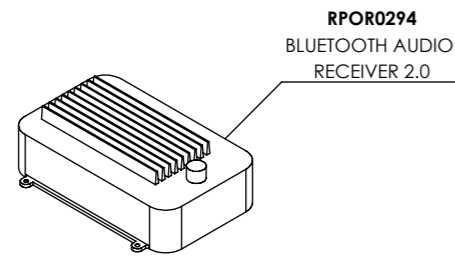

RPOR0321 - CONNECTORS CABLE SYSTEM 2.1

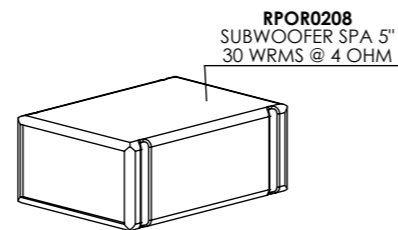
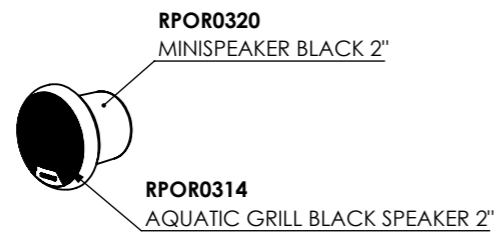

LIGHT COMPONENTS SPARE CODES

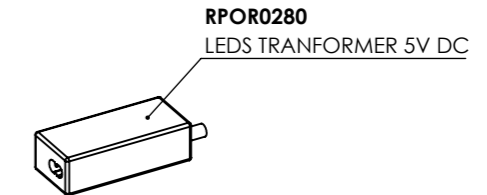
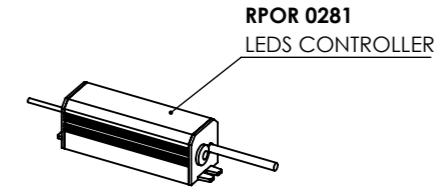

PURE LINE LIGHTING SPARE CODES

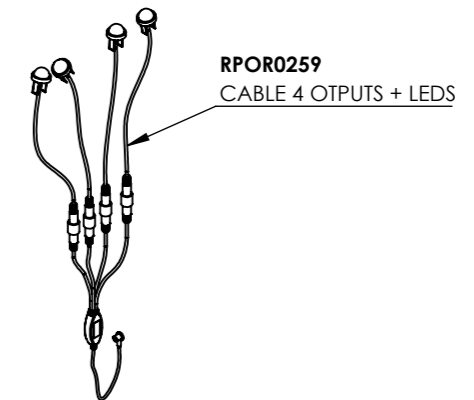

According to our policy of continuous improvement, dimensions, features or components of this product can be partially or completely changed without prior notice. It's Customer responsibility to verify that this is the last version of the drawing

10	18/09/2018	A.Miquel	Jets (CMP) changed.
09	08/05/2017	O. Faura	Changing of electronic parts references.
08	07/10/2014	I.Pozo	Change Blower 700W and add transformer/controler
07	13/01/2017	R.Vallès	Update measures
Change No.	Date	Name	Modification
Remarks			SPARE PARTS DRAWING
Dimensions in mm. General Tolerances +/- 10mm			
Drawn	13/01/2017	R.Vallès	
Checked	13/01/2017	V. Saiz	
Scale 1:5	General Tolerance		
Sheet 3/3	DIN 7168 ISO 2768g		
Part Number		Rev.	First Angle Projection
56541		10	