

↑
DRAIN
SIDE

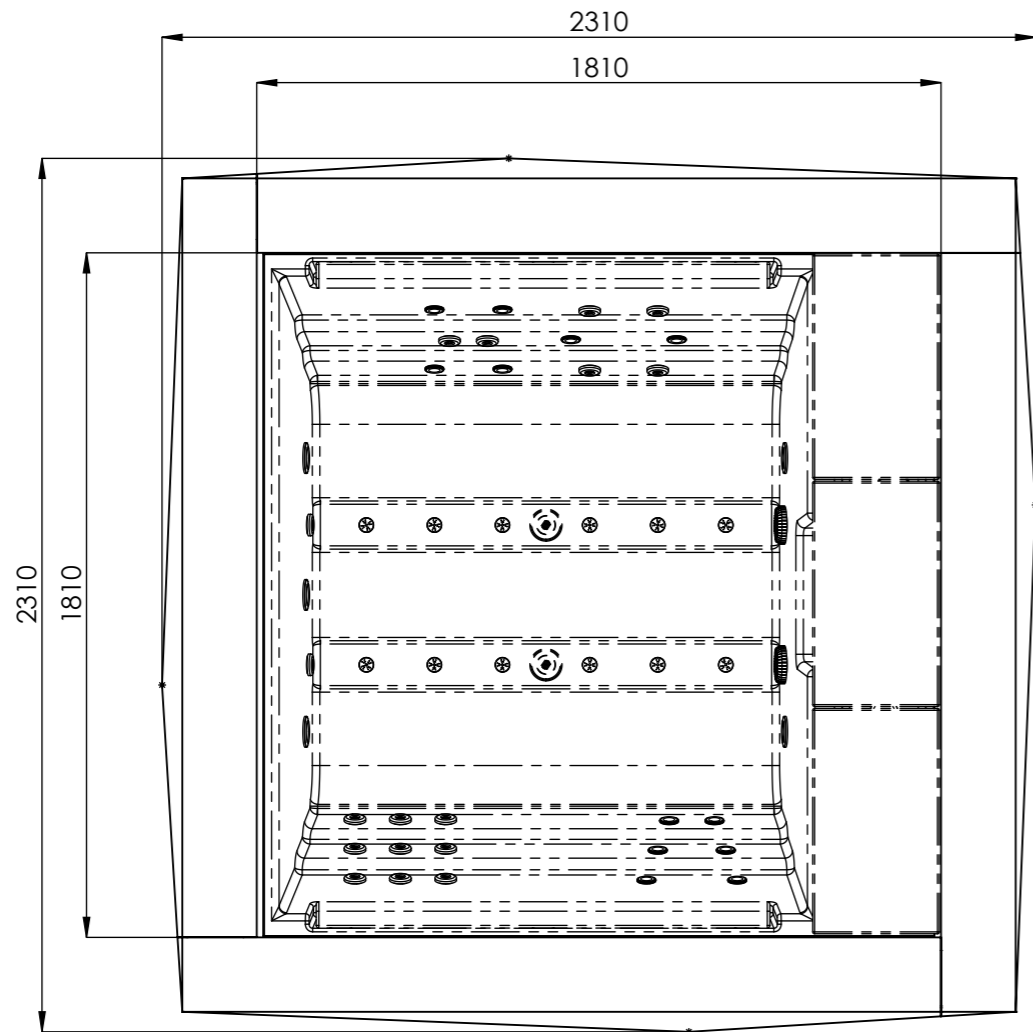

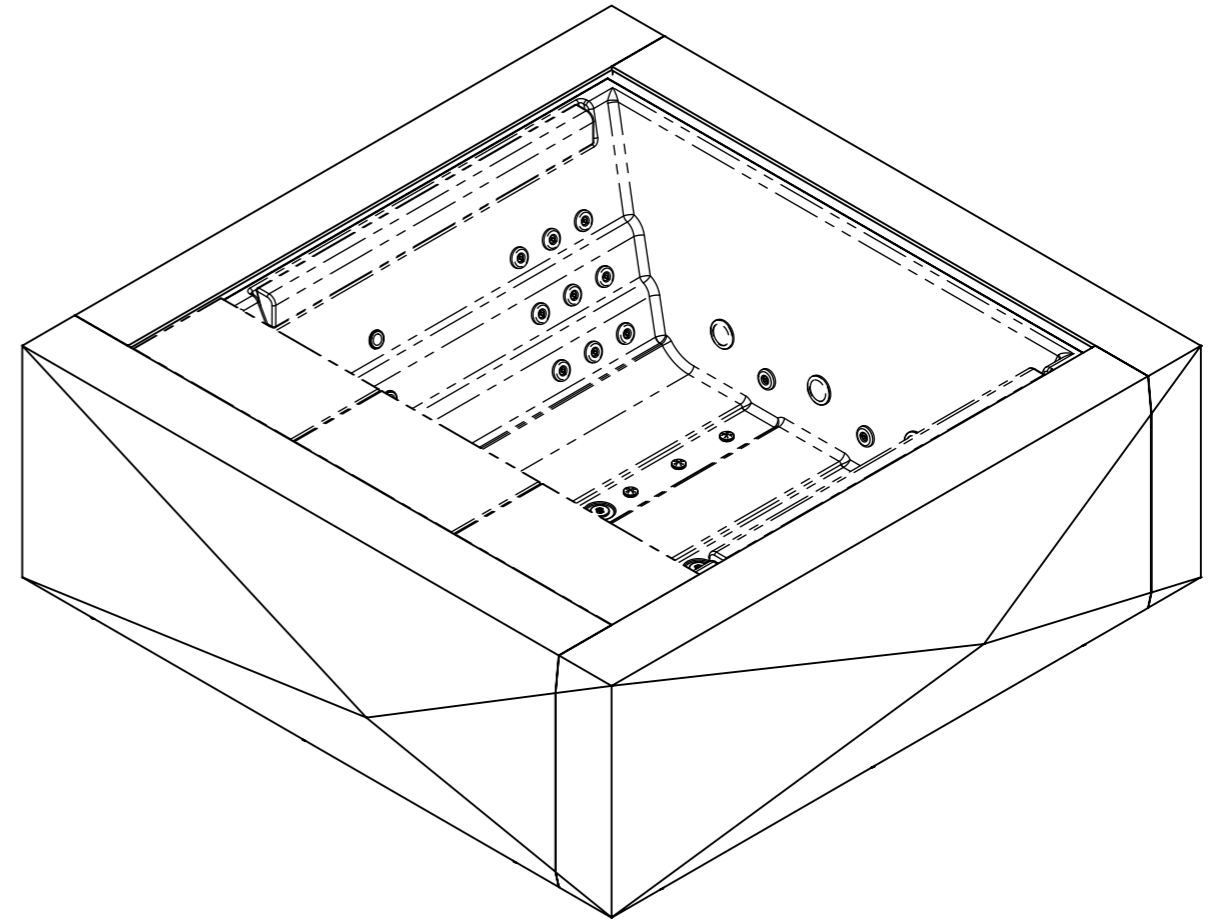

↑
DRAIN
SIDE

↑
↑
ELECTRICAL BOARD CONNECTIONS ACCESS



According to our policy of continuous improvement, dimensions, features or components of this product can be partially or completely changed without prior notice.
It's Customer responsibility to verify that this is the last version of the drawing

Change No.	Date	Name	Modification				
Remarks				COMMERCIAL			
Dimensions in mm. General Tolerances +/- 10mm							
Drawn	26/01/2018	R.Valles			Part Number	Rev.	First Angle Projection
Checked	26/01/2018	V. Saiz			69944	00	
Scale 1:20	General Tolerance						
Sheet 1/3	DIN 7168 ISO 2768g						
Property of IBERSPA S.L. Avda. Pla d'Urgell 2-8 25200 Cervera, Spain. Don't use without permission. Keep this information confidential and use it solely for the permitted purpose.							

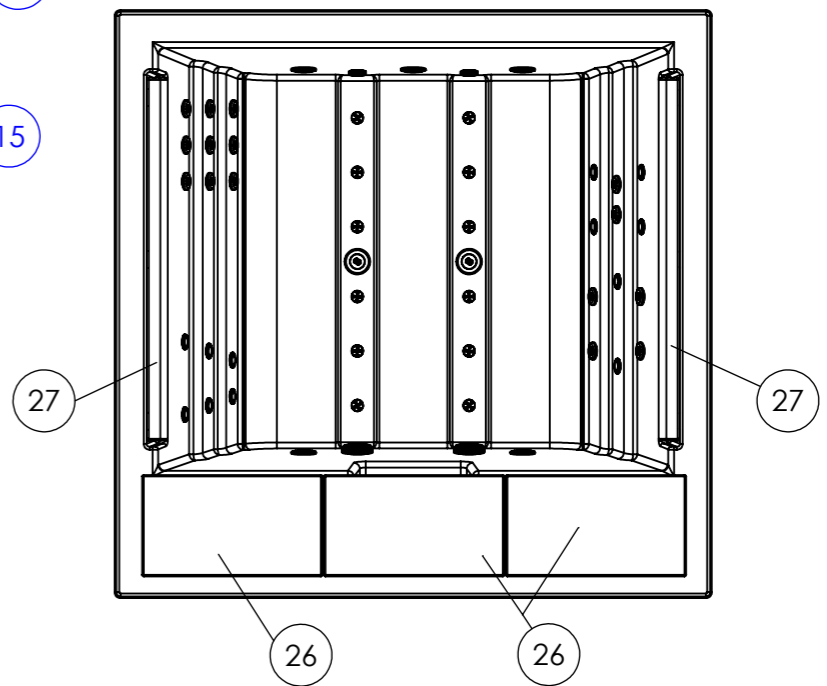
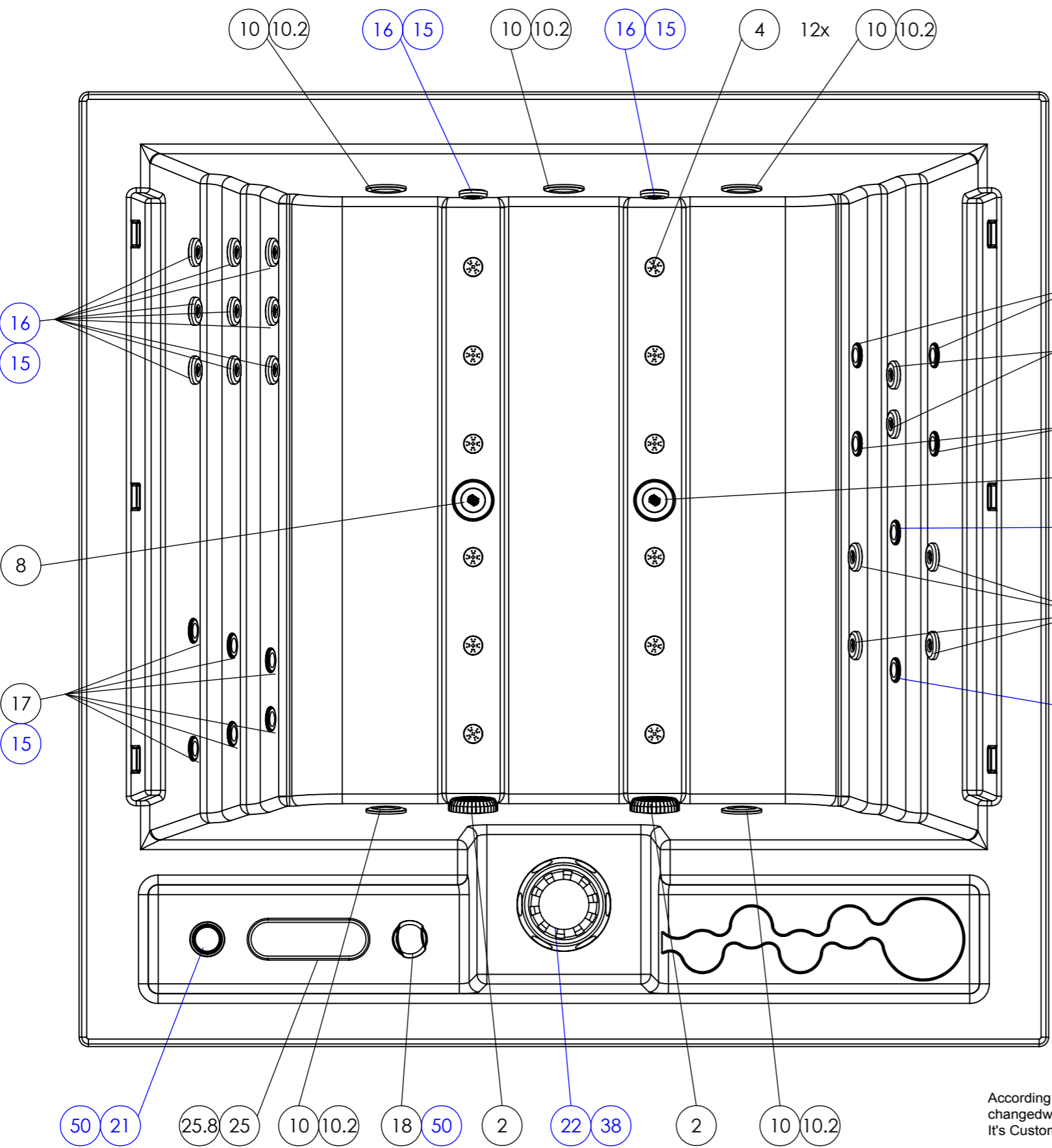

ACCESSORIES			
Position Num.	PartNo SPARE	Description SPARE	Quant.
2	RPOR0225	GREY SPA DRAIN 2" ADAPTOR SOCKET D.50	2
4	REMP0046	WHITE-STAINLESS STEEL AIR NOZZLE	12
8	RPOR0003	GREY DRAIN SET - BODY+COVER+ASSEMBLY	2
10	RPOR0239	SPOTLIGHT LED SET RD	5
10.2	RPOR0252	LED SLAVE LIGHT	5
15	RPOR0235	JET BODY SET RD 2"	29
17	RPOR0260	JET TWIN ROTO 2" INOX	17
18	RPOR0261	VENTURY CONTROLLER SS	1
21	RPOR0264	AROMA DISPENSER ASM LIT	1
22	RPOR0238	SKIMERFILTER RD LOW PROFILE	1
25	RPOR0356	CONTROL PANEL TP800	1
25.8	RPOR0356-B	COVER DIGITAL AQUAVIA PANEL TP800 (1 PUMP + BLOWER)	1
26	RPOR0269	TOP COVER CUBE SPA	3
27	RPOR0270	HEADREST CUBE SPA	2
38	RPOR0247	FILTER CARTRIDGE SKIMFILTER RD	1
49	RPOR0136	DRAIN FILL VALVE (BLACK)	1
50	RPOR0267	4 LEDS LIGHTS POINTS	1
70	RPOR0280	LEDS TRANSFORMER 5V DC	1
71	RPOR0281	LEDS CONTROLER	1
73	RPOR0259	CABLE 4 OUTPUTS + LEDS	8
100	RPOR0314	AQUATIC GRILL BLACK SPEAKER 2"	4
101	RPOR0320	MINISPEAKER BLACK 2"	4

According to our policy of continuous improvement, dimensions, features or components of this product can be partially or completely changed without prior notice. It's Customer responsibility to verify that this is the last version of the drawing

Changing of electronic parts references.			
Change No.	Date	Name	Modification
Remarks			
Dimensions in mm. General Tolerances +/- 10mm			
Drawn	26/01/2018	R.Valles	
Checked	26/01/2018	V. Saiz	
Scale 1:10	General Tolerance DIN 7168 ISO 2768g		
Sheet 2/3			SPARE PARTS DRAWING Part Number 69944 Rev. 00 First Angle Projection
Property of IBERSPA S.L. Avda. Pla d'Urgell 2-8 25200 Cervera, Spain. Don't use without permission. Keep this information confidential and use it solely for the permitted purpose.			

PUMPS SPARE CODES

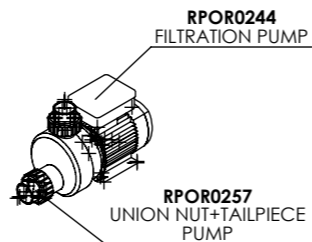
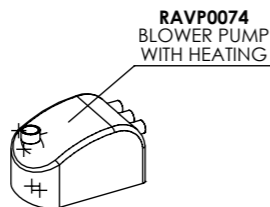
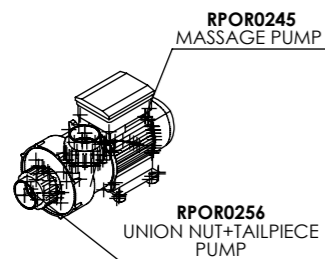

RPOR0136
DRAIN FILL VALVE (BLACK)

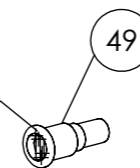

HEATER AND DESINFECTION SPARE CODES

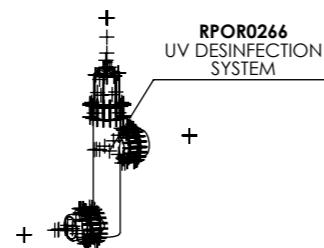
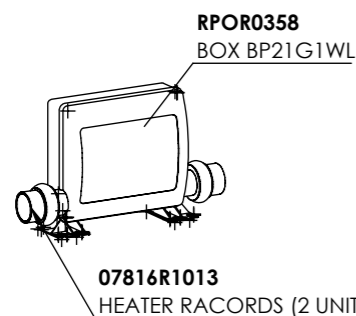

LIGHT COMPONENTS SPARE CODES

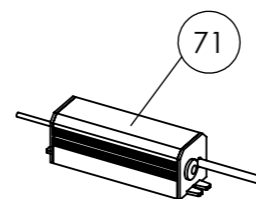
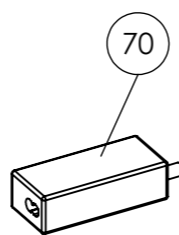

- RPOR0101 - TEMPERATURE PROBES GS I GL (x2)
- RPOR0105 - HEATER 3KW GS I GL
- RPOR0358-A - DIGITAL PANEL BP21G1WL
- RPOR0330 - EXPANDER BOARD KIT FOR SISTEM BP21G1WL
- RPOR0358-B - LEVEL SENSOR

PURE LINE LIGHTING SPARE CODES

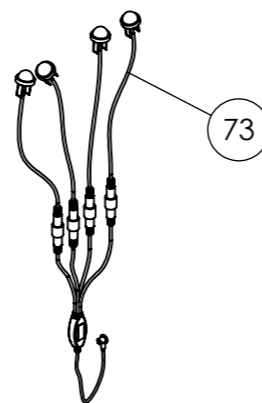

AUDIO SPARE CODES

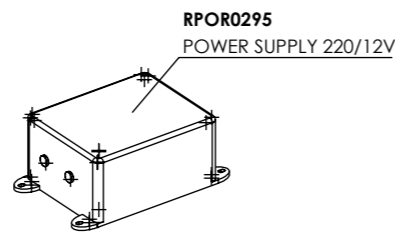
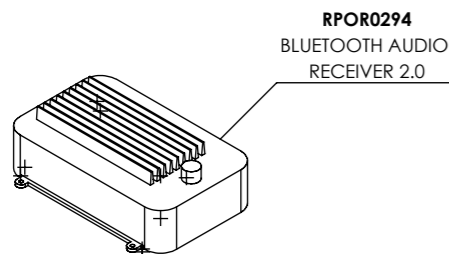

RPOR0321 - CONNECTORS CABLE SYSTEM 2.1

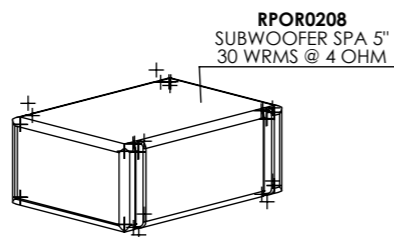
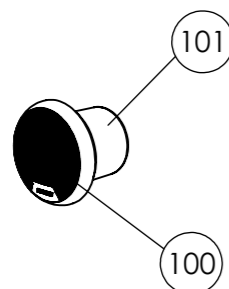

According to our policy of continuous improvement, dimensions, features or components of this product can be partially or completely changed without prior notice. It's Customer responsibility to verify that this is the last version of the drawing

ACCESSORIES			
Position Num.	PartNo SPARE	Description SPARE	Quant.
2	RPOR0225	GREY SPA DRAIN 2" ADAPTOR SOCKET D.50	2
4	REMP0046	WHITE-STAINLESS STEEL AIR NOZZLE	12
8	RPOR0003	GREY DRAIN SET - BODY+COVER+ASSEMBLY	2
10	RPOR0239	SPOTLIGHT LED SET RD	5
10.2	RPOR0252	LED SLAVE LIGHT	5
15	RPOR0235	JET BODY SET RD 2"	29
17	RPOR0260	JET TWIN ROTO 2" INOX	17
18	RPOR0261	VENTURY CONTROLLER SS	1
21	RPOR0264	AROMA DISPENSER ASM LIT	1
22	RPOR0238	SKIMERFILTER RD LOW PROFILE	1
25	RPOR0356	CONTROL PANEL TP800	1
25.8	RPOR0356-B	COVER DIGITAL AQUAVIA PANEL TP800 (1 PUMP + BLOWER)	1
26	RPOR0269	TOP COVER CUBE SPA	3
27	RPOR0270	HEADREST CUBE SPA	2
38	RPOR0247	FILTER CARTRIDGE SKIMFILTER RD	1
49	RPOR0136	DRAIN FILL VALVE (BLACK)	1
50	RPOR0267	4 LEDS LIGHTS POINTS	1
70	RPOR0280	LEDS TRANSFORMER 5V DC	1
71	RPOR0281	LEDS CONTROLER	1
73	RPOR0259	CABLE 4 OUTPUTS + LEDS	8
100	RPOR0314	AQUATIC GRILL BLACK SPEAKER 2"	4
101	RPOR0320	MINISPEAKER BLACK 2"	4

Changing of electronic parts references.			
Change No.	Date	Name	Modification
Remarks			SPARE PARTS DRAWING
Dimensions in mm. General Tolerances +/- 10mm			
Drawn	26/01/2018	R. Vallès	
Checked	26/01/2018	V. Saiz	
Scale	1:5	General Tolerance	Part Number 69944
Sheet	3/3	DIN 7168 ISO 2768g	
			Rev. 00
			First Angle Projection